

# Modeling and Computed Torque Control of a 6 Degree of Freedom Robotic Arm

Muhammad Imran Ullah<sup>1</sup>, Syed Ali Ajwad\*<sup>1</sup>, Raza Ul Islam<sup>1,2</sup>, Usama Iqbal<sup>1</sup> and Jamshed Iqbal<sup>1</sup>

<sup>1</sup>*Department of Electrical Engineering,  
COMSATS Institute of Information Technology,  
Islamabad, 44000, Pakistan*

<sup>2</sup>*Center of Advance Studies in Telecommunication (CAST),  
COMSATS Institute of Information Technology,  
Islamabad, 44000, Pakistan*

ajjimran@yahoo.com, s.ajwad@comsats.edu.pk, m.razaulislam@yahoo.com, usama.iqbal@yahoo.com,  
jamshed.iqbal@comsats.edu.pk

## **\*Corresponding Author:**

**Name: Syed Ali Ajwad**

**Email Address: s.ajwad@comsats.edu.pk**

**Contact Number (office): 0092 519049236**

**Contact Number (mobile): 0092 3328329840**

# Modeling and Computed Torque Control of a 6 Degree of Freedom Robotic Arm

**Abstract** - This paper presents modeling and control design of ED 7220C – a vertical articulated serial arm having 5 revolute joints with 6 Degree Of Freedom. Both the direct and inverse kinematic models have been developed. For analysis of forces and to facilitate the controller design, system dynamics have been formulated. A non-linear control technique, Computed Torque Control (CTC) has been presented. The algorithm, implemented in MATLAB/Simulink, utilizes the derived dynamics as well as linear control techniques. Simulation results clearly demonstrate the efficacy of the presented approach in terms of trajectory tracking. Various responses of the arm joints have been recorded to characterize the performance of the control algorithm. The research finds its applications in simulation of advance non-linear and robust control techniques as well as their implementation on the physical platform.

**Index Terms** – Mathematical modeling, Arm Kinematics and Dynamics, Controller Design, Multi-DOF robotic manipulator

## I. INTRODUCTION

Robots were initially designed as a source of fun and entertainment. By the time field of robotics get advanced, it changed the face of its preliminary purpose. Now robots are essential part of automated industries. They become more of a need than a luxury for industrial growth [1,2]. Additionally, robots are being used for rehabilitation [3-6], assistance [7,8], Virtual Reality (VR) [9], nuclear power plants [10] and so on. Robotics is the growing field of engineering. Currently it is among the most interesting topics for scientists as it is core part of future economy, warfare and medicine.

Kinematic problem is associated with the motion of robot. It does not deal with the forces that cause the motion. It is further divided into two categories, a) Forward Kinematic (FK), b) Inverse Kinematics (IK). FK deals with the computation of end-effector coordinates knowing the achieved joint angles. The model can be computed through various methods. Denavit–Hartenberg (DH) and successive screw displacement are most commonly used methods for kinematic modeling. In DH formulation approach, first DH parameters are defined. Having the knowledge of these parameters, the kinematic model can be described for any robot [11]. In contrast to FK, IK model computes the required joint angles for the given coordinates and is more complex than FK [12].

A number of research works has been presented relating to the modeling of Kinematics. Shi *et al.* have proposed the general solution for FK problem of 6 Degree Of Freedom (DOF) robot [13]. Kumar *et al.* have reported FK and IK solution for a virtual robot [14]. IK of serial link robotic arm has been proposed by Cubero [15]. To compute the required joint angles for any desired position of arm, geometric solution has been provided by Clothier *et al.* [16].

Moving ahead towards control design, dynamic model is an important topic [17]. In dynamic modeling, forces and torques acting on the robot are taken into account [18]. Different approaches for dynamics computation have been discovered by researchers. Newton–Euler and Euler-Lagrange formulations are commonly used for dynamics modeling.

Controller design demands the mathematical model of the robotic arm. Robot modeling involves two types of models, Kinematic model and Dynamic model discussed earlier. To operate the robotic manipulator with absolute precision and at high speed control strategy has to be well defined. Robot dynamics, payload, operating environment are the main challenges in designing the control system.

Classical as well as robust and adaptive control techniques have been reported in research community. Proportional Derivative (PD) and Proportional Integral Derivative (PID) are the basic and mostly utilized classical control techniques have been implemented on mobile robots [19] and on industrial robotic arm presented in [20]. In Modern control techniques, utilization of robot dynamics for cancelling out its nonlinear dynamics along with the Classical control techniques has made the system to work more efficiently and effectively. Work has been reported in [21], combining Computed Torque Control (CTC) with PD and PID. Based on CTC, [22] presents a comparison between Locally Weighted Projection Regression (LWPR) and Gaussian Process Regression (GPR).

This paper is outlined as follows: Section II describes the Robot modeling. The designed control algorithm and its results are presented in Section III and finally Section IV concludes the work.

## II. MODELING OF ROBOTIC ARM

A 6 DOF robotic manipulator ED7220C has been used in the current research work. The robotic arm has 5 revolute joints include tool, wrist, elbow, shoulder, waist or base joints as shown in Fig. 1. Each joint is actuated through servo motor. To make the system close loop, position feedback is obtained by optical encoders. These kind of robotic manipulators are commonly used in teaching and research. Link specifications of robotic arm have been depicted in Table 1 below.

TABLE 1  
LINK SPECIFICATIONS

Links	DOF	Link Lengths
Base	1	385
Shoulder	1	220
Elbow	1	220
Wrist	2	155

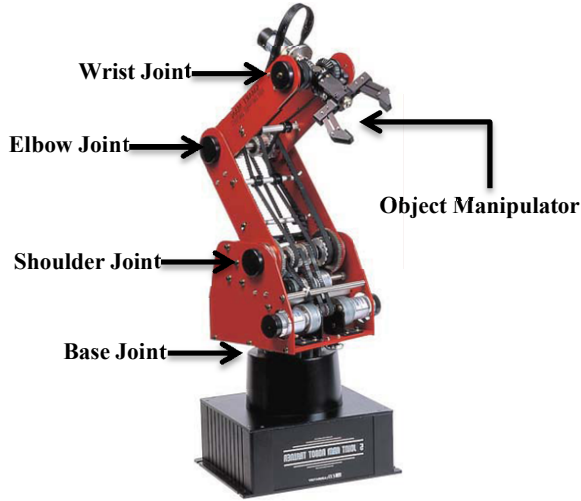

Fig. 1 ED7220C joints

#### A. Kinematic Model

Kinematic model deals with the motion of robot without including the forces that cause the motion. All geometric and time based properties of robot motion are involved in study of kinematics. Analysis of kinematics consists of Forward and Inverse Kinematic.

The procedure use to get end – effector coordinates from known joints angles is called forward or direct kinematics. Fig. 2 shows the kinematic model of ED7220C robotic manipulator. DH parameter based kinematic model, has been derived for robotic arm ED7220C. Frame assignment is shown in Fig. 3. The wrist joint having 2 DOF so it is represented as tool pitch and tool roll. After attachment of frames to each joint, DH parameters have been derived and are given in Table 2 [1].

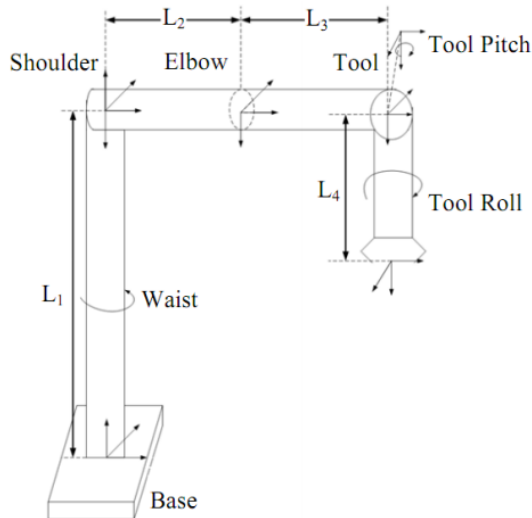

Fig. 2 Kinematic modeling

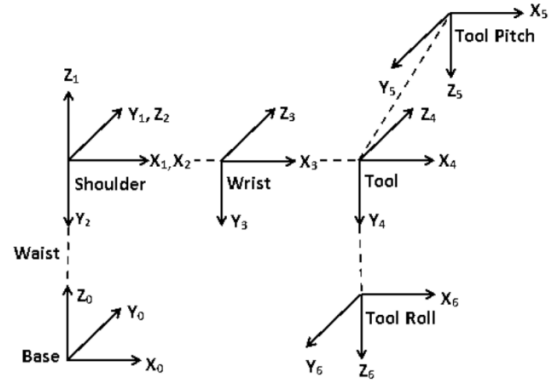

Fig. 3 Frames assignment

The following definitions have been used.

- $\alpha_{i-1}$  = Angle from  $Z_{i-1}$  to  $Z_i$  measured about  $X_{i-1}$
- $a_{i-1}$  = Distance from  $Z_{i-1}$  to  $Z_i$  measured along  $X_{i-1}$
- $d_i$  = Distance from  $X_{i-1}$  to  $X_i$  measured along  $Z_i$
- $\theta_i$  = Angle from  $X_{i-1}$  to  $X_i$  measured about  $Z_i$

where “i” is the frame number.

TABLE 2  
DH PARAMETERS

Parameters	Joint (i)					
	1	2	3	4	5	6
Link twist ( $\alpha_{i-1}$ )	0	-90°	0	0	-90°	0
Link length ( $a_{i-1}$ )	0	0	$l_2$	$l_3$	0	0
Joint distance ( $d_i$ )	$l_1$	0	0	0	0	$l_4$
Joint angle ( $\theta_i$ )	$\theta_1$	$\theta_2$	$\theta_3$	$\theta_4$	$\theta_5$	0

Based on these parameters, the transformation matrix  ${}^0T_6$  includes the overall rotation and translation of tool frame {6} with respect to base frame {0}. The transformation matrix is given by (1)

$${}^0T_6 = \begin{bmatrix} c_1 c_{234} c_5 + s_1 s_5 & -c_1 c_{234} s_5 + s_1 c_5 & -c_1 s_{234} & c_1 A \\ s_1 c_{234} c_5 - c_1 s_5 & -s_1 c_{234} s_5 - c_1 c_5 & -s_1 s_{234} & s_1 A \\ -s_{234} c_5 & s_{234} s_5 & -c_{234} & B \\ 0 & 0 & 0 & 1 \end{bmatrix} \quad (1)$$

First 3x3 sub matrix of transformation matrix gives rotation and first 3 elements of the last column gives the position, i.e.

$$\begin{bmatrix} X \\ Y \\ Z \end{bmatrix} = \begin{bmatrix} C_1 A \\ S_1 A \\ B \end{bmatrix}$$

where A and B are given by

$$A = -l_4 s_{234} + l_3 c_{23} + l_2 c_2$$

$$B = l_1 - l_4 c_{234} - l_3 s_{23} - l_2 s_2$$

and

$$c_a = \cos(a), c_{ab} = \cos(a + b), c_{abc} = \cos(a + b + c)$$

$$s_a = \sin(a), s_{ab} = \sin(a + b), s_{abc} = \sin(a + b + c)$$

To achieve the desired position and orientation of end – effector, the required joint angles can be calculated by IK. IK

model of robotic arm has been computed by Algebraic and Geometric methods. The orientation of gripper has been realized geometrically while the closed form equations for each joint angle of the robotic arm have been derived algebraically.  $\theta_1$  is given by (2).

$$\theta_1 = \text{Atan2}(p_y, p_x) \quad (2)$$

The required joint angles ( $\theta_2, \theta_3, \theta_4$ ) can then be computed by (3), (4) and (5) which are as follows:

$$c_3 = \frac{(c_1 p_x + s_1 p_y + l_4 s_{234})^2 + (p_z - l_1 + l_4 c_{234})^2 - l_2^2 - l_3^2}{2l_2 l_3} \quad (3)$$

$$s_3 = \pm \sqrt{1 - c_3^2}$$

$$\theta_3 = \text{Atan2}(s_3, c_3)$$

$$c_2 = \frac{(c_1 p_x + s_1 p_y + l_4 s_{234})(c_3 l_3 + l_2) - (p_z - l_1 + l_4 c_{234})s_3 l_3}{(c_3 l_3 + l_2)^2 + s_3^2 l_3^2}$$

$$s_2 = -\frac{(c_1 p_x + s_1 p_y + l_4 s_{234})s_3 l_3 + (p_z - l_1 + l_4 c_{234})(c_3 l_3 + l_2)}{(c_3 l_3 + l_2)^2 + s_3^2 l_3^2}$$

$$\theta_2 = \text{Atan2}(s_2, c_2) \quad (4)$$

$$\theta_4 = \theta_{234} - (\theta_2 + \theta_3) \quad (5)$$

### B. Dynamic Model

Dynamic model deals with the forces and torques causing the motion of the body [18]. In this research work, robotic arm dynamic model has been computed by Euler-Lagrange formulation. This energy based formulation [23] is comparatively compact and simple. Nomenclature used to derive dynamic model has been mentioned in Table 3.

TABLE 3  
DYNAMIC NOMENCLATURE

Symbol	Description
$m_i$	$i^{\text{th}}$ link mass
$v_{ci}$	$i^{\text{th}}$ link linear velocity
${}^i \omega$	$i^{\text{th}}$ link angular velocity
${}^i I$	$i^{\text{th}}$ link inertia tensor
${}^c P$	$i^{\text{th}}$ link Position

The potential and kinetic energies of individual link has been calculated by (6) and (7)

$$u_i = -m_i g^T c_i P \quad (6)$$

$$k_i = \frac{1}{2} m_i v_{ci}^T v_{ci} + \frac{1}{2} {}^i \omega^T {}^i I {}^i \omega \quad (7)$$

The difference of total potential energy and kinematic energy has been used to compute Lagrangian [11] and the Torque (8) for each link is then computed by differentiating Lagrangian w.r.t  $\dot{\theta}$  and  $\theta$ .

$$\tau = M(q)\ddot{q} + V(q, \dot{q}) + G(q) \quad (8)$$

where  $\tau$  is the joint torque,  $M(q)$  represents the inertia tensor,  $V(q, \dot{q})$  represents Centrifugal and Corollis forces and  $G(q)$

matrix is representing gravity. The derived model has been given in [24].

The inertia matrix is always semi – positive definite. This property of inertia matrix has been used to verify the dynamic model. The joint trajectories are shown in Fig. 4 and the consequent positive definite conditions as well as the required joint torques to accomplish this motion are shown in Fig. 5 and Fig. 6 respectively.

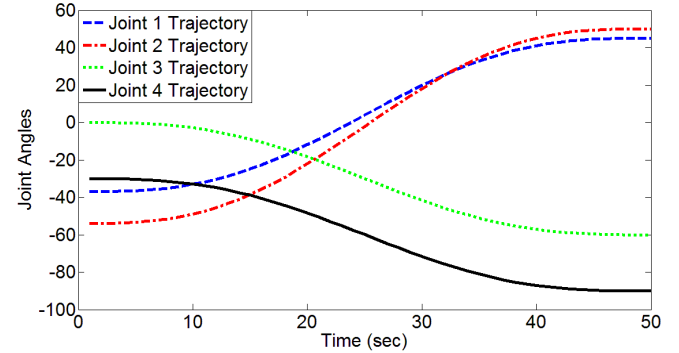

Fig. 4 Joints trajectory

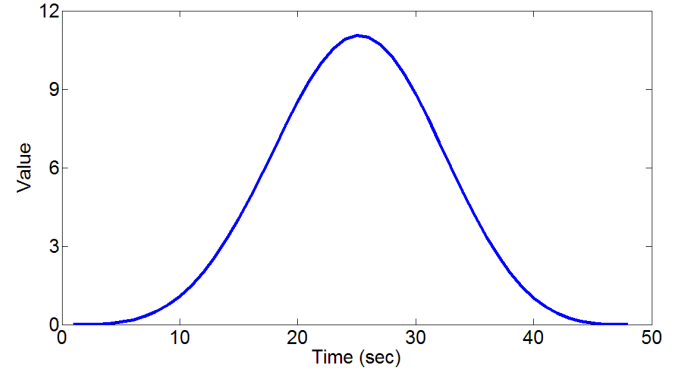

Fig. 5 Positive-definite condition

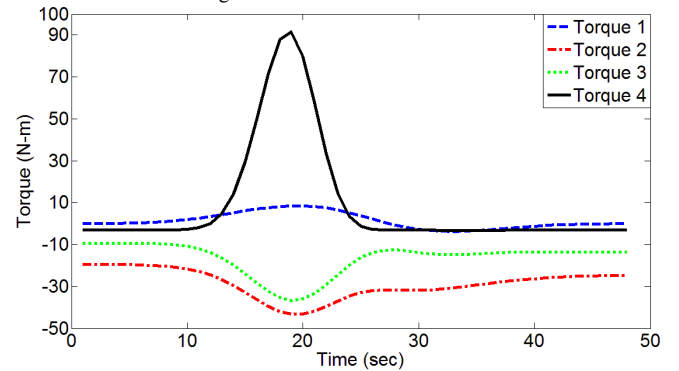

Fig. 6 Joints torque

## III. CONTROL DESIGN

### A. Computed Torque Control

CTC is a fundamental non-linear control technique applied to nullify the nonlinear behavior of the system. The dynamics that are modeled will determine the feedback loop for the control design. In the presence of an exact dynamic model, CTC works well and results in good performance parameters. It is not almost impossible but practically an accurate dynamic

model is very difficult to achieve. Moreover the dynamics of a robotic manipulator change significantly when a heavy payload is picked up [25]. These changes result in performance degradation of the manipulator's trajectory-tracking. To surpass this degradation, many researchers have proposed advanced CTC techniques like model based fuzzy controller to obtain the desired control and a fuzzy switching control to reinforce closed loop system performance [26]. In [27] Soltani *et al.* proposed fuzzy CTC to estimate nonlinear dynamics.

The dynamic model of the robotic manipulator is nonlinear function of states variables (joint positions and velocities). This establishes a guideline for the required controller to be a nonlinear function of the states. CTC is one such control which is model based. Here linearization and decoupling is accomplished through deploying robot dynamics in the feedback loop. The CTC with Proportional-Derivative (PD) control is given by

$$\tau = M(q)v + V(q, \dot{q}) + g(q) \quad (9)$$

where the auxiliary control signal is

$$v = \ddot{q}_d - K_v \dot{e} - K_p e \quad (10)$$

having  $v = [v_1 \ v_2 \ v_3 \ v_4]^T$  is the input and  $e = q_d - q$  is the position tracking error. Now solving for the closed loop, the error dynamics are calculated as under

$$\ddot{e} + K_v \dot{e} + K_p e = 0 \quad (11)$$

A practical approach is to decouple the multivariable linear system of error dynamics of each joint independently. This could be achieved easily by taking  $K_p$  and  $K_v$  diagonal matrices [28] as under

$$\begin{aligned} K_p &= \text{diag} \{ \lambda_1^2 \ \lambda_2^2 \ \lambda_3^2 \ \lambda_4^2 \} \\ K_v &= \text{diag} \{ 2\lambda_1 \ 2\lambda_2 \ 2\lambda_3 \ 2\lambda_4 \} \end{aligned} \quad (12)$$

Now each joint respond as a critically damped linear system where the error converge to zero exponentially [29].

$$\ddot{e} + 2\lambda_i \dot{e} + \lambda_i^2 e = 0, \quad i = 1, 2, 3 \text{ or } 4 \quad (13)$$

### B. Results and Discussion

The simulation is performed using Matlab/Simulink. The Simulink model is given in Fig. 7.

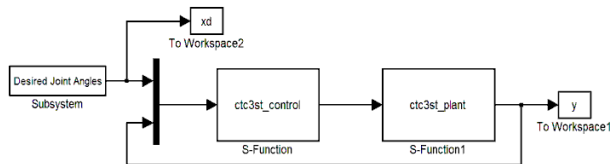

Fig. 7 Developed Simulink model

The robotic manipulator ED7220C is modeled in `ctc3st_plant` (S-Function1) and CTC algorithm is embedded in

`ctc3st_control` (S-Function). Desired joint angles ( $q_d$ ) and actual joint angles ( $q$ ) are exported to the Simulink workspace for taking the plots given below.

Simulations have been done by considering different values of  $\lambda$  (1, 2 and 4). The difference between responses is evident in Fig. 8-10. The tracking responses have been plotted by giving different inputs to each link. It can be observed that by increasing the  $\lambda$  the performance of the system has improved.

As there is no overshoot for each value of  $\lambda$  but there is significant difference in reaching time to desired response. For  $\lambda=1$ , the settling time for the step and ramp input is almost 7 sec. and in the case of sine input it is 6 sec. As the  $\lambda$  is changed to 2 the settling time to each input has reduced. In the case of  $\lambda=4$  the settling time in case of step and ramp has reduced to 1.4 and 2.3 sec. respectively and for sine input it is 0.8 sec.

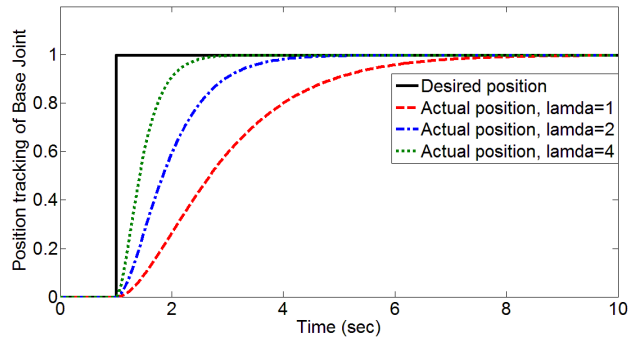

Fig. 8 Step response of joint 1

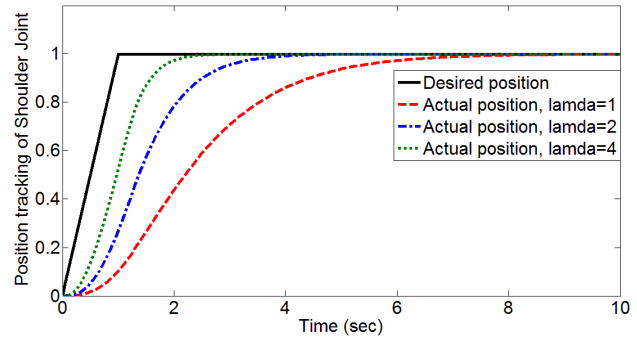

Fig. 9 Ramp response of joint 2

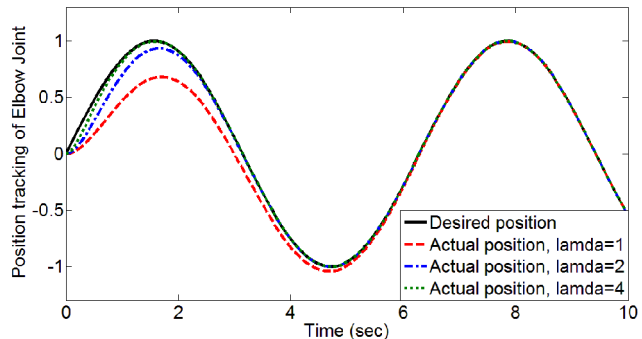

Fig. 10 Sinusoidal response of joint 3

#### IV. CONCLUSION

The work presented in this paper provides a complete path from modeling Kinematics to design of Control system of a 6 DOF robotic arm. Control technique CTC utilizes the modelled dynamics of the robotic arm to design a feedback loop, cancelling the non-linearities of the system and then further on utilizing the linear control techniques to achieve the desired response. Designed platform has immense capabilities in the field of research and academics activities. The implementation of CTC on real platform is under development. It is envisaged in near future to design advance non-linear control techniques followed by their testing on a real platform.

#### REFERENCES

- [1] R.ul Islam, J. Iqbal, S. Manzoor, A. Khalid and S. Khan, "An autonomous image-guided robotic system simulating industrial applications", 7th IEEE International Conference on System of Systems Engineering (SoSE), Italy, 2012, pp. 344-349.
- [2] A. Meddahi, K. Baizid, A. Younsadj and J. Iqbal, "API based graphical simulation of robotized sites", 14th IASTED International Conference on Robotics and Applications (RA), Massachusetts US, 2009, pp. 485-492.
- [3] J. Iqbal, A.H. Khan, N.G. Tsagarakis and D.G. Caldwell, "A novel exoskeleton robotic system for hand rehabilitation - Conceptualization to prototyping", Biocybern Biomed Engineering, 2014, In Press
- [4] J. Iqbal, N.G. Tsagarakis, A.E. Fiorilla and D.G. Caldwell, "A portable rehabilitation device for the hand", 32nd annual IEEE international conference of Engineering in Medicine and Biology Society [EMBS], Buenos Aires, Argentina, 2010, pp. 3694-3697.
- [5] J. Iqbal, N.G. Tsagarakis and D.G. Caldwell, "A human hand compatible optimised exoskeleton system", IEEE international conference on Robotics and Biomimetics [ROBIO], China, 2010, pp. 685-690.
- [6] J. Iqbal, N.G. Tsagarakis and D.G. Caldwell, "Design optimization of a hand exoskeleton rehabilitation device", Proceedings of RSS workshop on understanding the human hand for advancing robotic manipulation, Seattle US, 2009, pp. 44-45.
- [7] J. Iqbal, N.G. Tsagarakis and D.G. Caldwell, "A multi-DOF robotic exoskeleton interface for hand motion assistance", 33rd annual IEEE international conference of Engineering in Medicine and Biology Society [EMBS], Boston, US, 2011, pp. 1575-1678.
- [8] A.A. Khan, S. Riaz and J. Iqbal, "Surface estimation of a pedestrian walk for outdoor use of power wheelchair based robot", Life Science Journal - Acta Zhengzhou University Overseas Edition, ISSN 1097-8135, 2013; 10[3]: 1697-1704.
- [9] J. Iqbal, N.G. Tsagarakis and D.G. Caldwell, "Design of a wearable direct-driven optimized hand exoskeleton device", 4th International Conference on Advances in Computer-Human Interactions [ACHI], France, 2011, pp. 142-146.
- [10] J. Iqbal, A. Tahir, R.ul Islam and R.un Nabi, "Robotics for nuclear power plants – Challenges and future perspectives", IEEE International Conference on Applied Robotics for the Power Industry [CARPI], Zurich, Switzerland, Sep. 2012, pp. 151-156.
- [11] J.J. Craig, "Introduction to robotics: mechanics and control", 2004
- [12] M.W. Spong, S. Hutchinson and M. Vidyasagar, "Robot modeling and control", New York, John Wiley & Sons, 2006
- [13] X. Shi and N.G. Fenton, "A complete and general solution to the forward kinematics problem of platform-type robotic manipulators", IEEE International Conference on Robotics and Automation Proceedings, 1994, pp. 3055-3062
- [14] R. Kumar, P. Kalra and N. Prakash, "A virtual RV-M1 robot system, robotics and computer-integrated manufacturing", Vol. 26, No. 6, 2011 pp. 994-1000
- [15] S.N. Cubero, "Blind search inverse kinematics for controlling all types of serial-link robot arms", Mechatronics and Machine Vision in Practice, Springer Berlin Heidelberg, 2008
- [16] K.E. Clothier and Y. Shang, "A geometric approach for robotic arm kinematics with hardware design, electrical design and implementation", Journal of Robotics, Article ID 984823, Vol. 2010
- [17] W. Khalil, "Dynamic modeling of robots using newton-euler formulation", Informatics in Control, Automation and Robotics, Springer, Berlin Heidelberg, 2011, pp. 3-20.
- [18] M.P. Groover, M. Weiss and R.N. Nagel, "Industrial Robotics: Technology, Programming and Application", McGraw-Hill Higher Education, 1986
- [19] J. Iqbal, S. R. un Nabi, A. A. Khan and H. Khan, "A novel track-drive mobile robotic framework for conducting projects on robotics and control systems," Life Science Journal 10, No. 3, 2013
- [20] Y. Antonio, S. Victor and M.V. Javier, "Global asymptotic stability of the classical PID controller by considering saturation effects in industrial robots", International Journal of Advance Robotic Systems, Vol. 8, 2011, pp. 34-42
- [21] F. Piltan, M. H. Yarmahmoudi, M. Shamsodini, E. Mazlomian, and A. Hosainpour, "PUMA-560 robot manipulator position computed torque control methods using Matlab/Simulink and their integration into graduate nonlinear control and Matlab courses", International Journal of Robotics and Automation 3, No. 3, 2012, pp. 167-191
- [22] N.T. Duy, S. Matthias and P. Jan, "Computed torque control with nonparametric regression models", IEEE American Control Conference, 2008, pp. 212-217
- [23] S. K. Saha, "Introduction to robotics" Tata McGraw-Hill, 2008
- [24] S. Manzoor, R.ul Islam, A. Khalid, A. Samad and J. Iqbal, "An open-source multi-DOF articulated robotic educational platform for autonomous object manipulation", Robotics and Computer Integrated Manufacturing 2014, 30(3), pp. 351-362
- [25] Q. Li, A.N. Poo and M. Ang, "An enhanced computed-torque control scheme for robot manipulators with a neuro-compensator." Systems, Man and Cybernetics, 1995. IEEE International Conference on Intelligent Systems for the 21st Century, Vol. 1, 1995, pp. 56-60
- [26] L. Reznik, "Fuzzy controllers handbook: how to design them, how they work", Access Online via Elsevier, 1997
- [27] S. Soltani and F. Piltan, "Design artificial nonlinear controller based on computed torque like controller with tunable gain", World Applied Science Journal 14, No. 9, 2011, pp. 1306-1312
- [28] R. Kelly, V.S. Davila, V. Santibáñez and A. Lorãia, "Control of robot manipulators in joint space", Springer, 2005
- [29] J.J.E. Slotine and W. Li, "Applied nonlinear control", Vol. 199, No. 1, New Jersey, Prentice hall, 1991